

PRODUCT CODE: AB16G
ADAPTABLE BOX - PLAIN

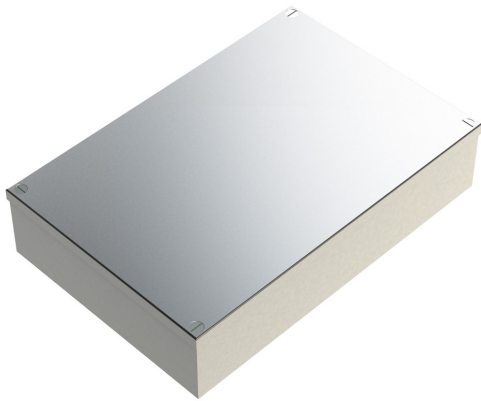

DESCRIPTION

225 x 150 x 50mm (9 x 6 x 2") Adaptable Box, Plain

FINISH

Pre Galvanised

MATERIAL

Galvanised Sheet Steel

PACKAGING

Packed in qty 5 (can be purchased individually)

ADDITIONAL NOTES

Comprises body, flanged cover and M5 x 10mm lid fixing screws
Plain sides (also available with pre-cut knockouts)
Compliant to LU Standard 1-085 (for use on surface & sub-surface locations)

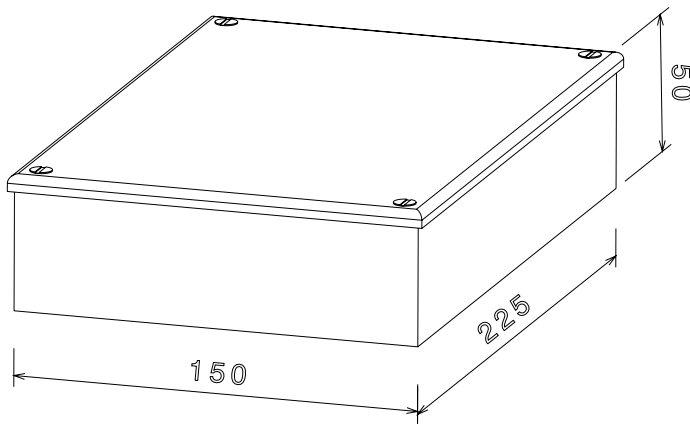

Isometric view

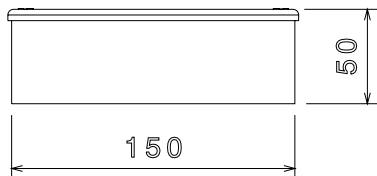

Front view

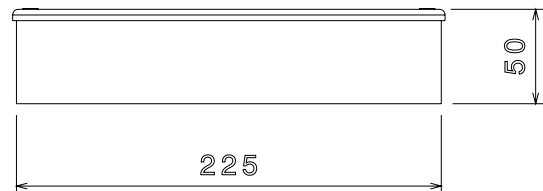

Side view